

FIRE HOSE REEL

LKS Mark 111 Maxi30

PRODUCT CODE

FHRMP3025

DIMENSIONS

Diameter : 555mm

Depth : 303mm

MATERIAL

Side Plates: CR-F Steel. Signal Red

Spacer Pins: Mild Steel. Zinc Plated

Fire Reel Hose: P.V.C. 25mm Internal Diameter

Hose Length: 30 metres

Nozzle: Jet Lever Action. DR Brass

Guide Arm: Swivel. Zinc Plated

Bracket: Easi-Fit. Galvanised

Inlet Pipe: Galvanised

Barrell Union: F&F. Galvanised

Spindle: DR Brass

Waterway: DR Brass

Isolation Valve: DR Brass. 25mm (M & F) #304

Stainless Steel Interlock & Handle

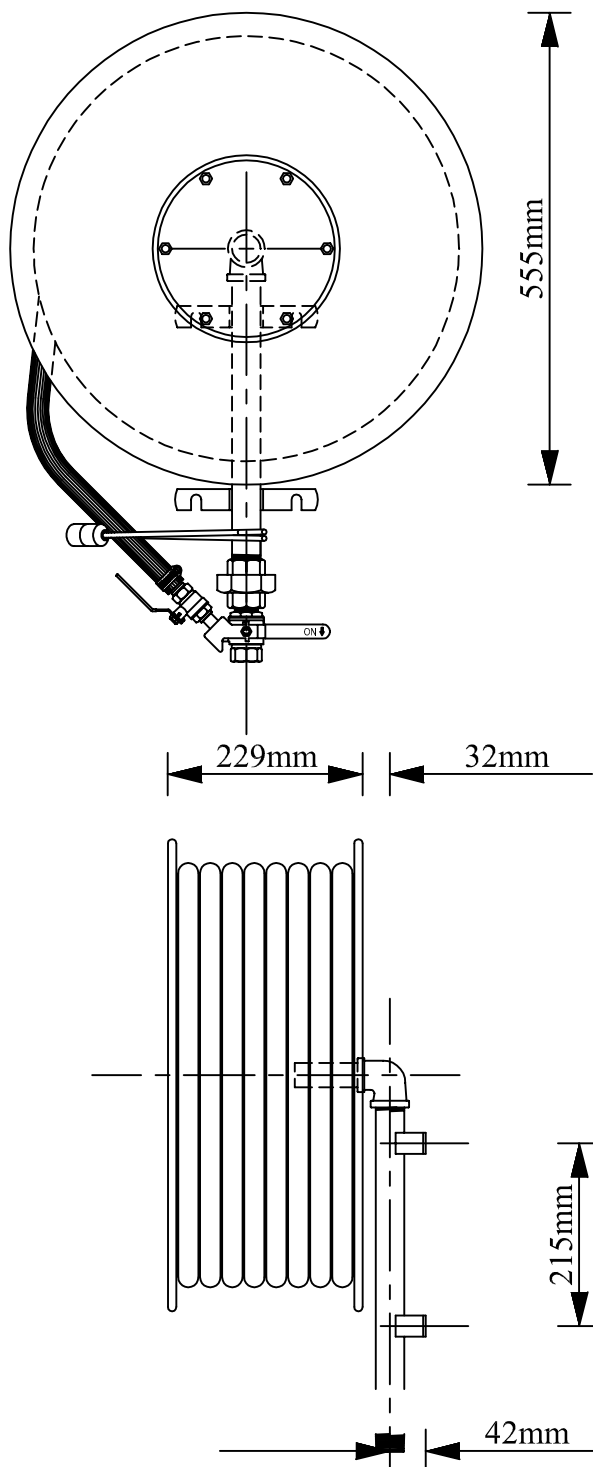

INSTALLATION

Drum Centre: 1400 - 2400mm

Isolation Valve Centre: 900 - 1100mm

RECOMMENDATION

Mounting the Isolation Valve at a height of 1060mm will achieve the Hose Reel centre height of 1500mm

If the minimum Isolation Valve height of 900mm is required, the length of the backpipe will need to be extended on site

Radial clearance of not less than 100mm must be maintained around the Hose Reel Plates and Isolating Valve