

FIRE HOSE REEL

LKS Mark 111 Maxi50

PRODUCT CODE

FHRMP5019

DIMENSIONS

Diameter : 555mm

Depth : 305mm

MATERIAL

Side Plates: Mild Steel. Painted Signal red

Spacer Pins: Mild Steel. Zinc Plated

Fire Reel Hose: P.V.C. 19mm Internal Diameter

Standard Hose Length: 50metres

Nozzle: Jet: Lever Action Brass

Guide Arm: Swivel. Zinc Plated

Bracket: Easi-Fit. Galvanised

Barrell Union: F&F. Galvanised

Spindle: Brass

Waterway: Brass

Isolation Valve: Brass. 25mm & Nozzle Interlock

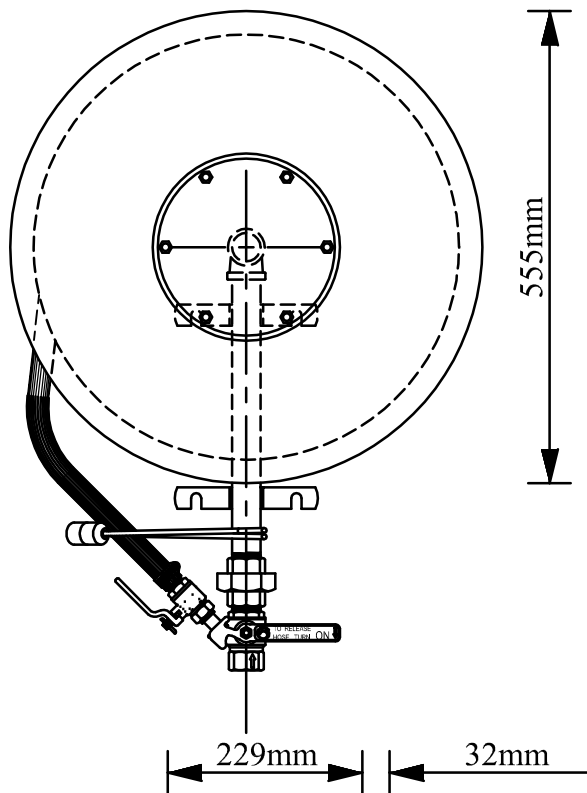

INSTALLATION

Drum Centre: 1400 - 2400mm

Isolation Valve Centre: 900 - 1100mm

RECOMMENDATION

Mounting the Isolation Valve at a height of 1060mm will achieve the minimum Hose Reel centre height of 1500mm

If the minimum Isolation Valve height of 900mm is required, the length of the backpipe will need to be extended on site

Radial clearance of not less than 100mm must be maintained around the Hose Reel Plates and Isolating Valve

